



Combi Clamp

Model No. 669g

incl. 669g-300, 500, 600, 700 & 800

**Instruction Manual
& Operating Guide**



Rev 'A' - November 2011

Contents

Combi Clamp - Model 669g

	Pages
General Overview	4
Setting up your Combi Clamp	5 - 8
Foot Positions for Operation	9 - 11
Setting up the Weigh Frame	12 - 13
Auxiliary Frame	14
Tru-test Weigh Indicators	15
Quick Start Guide - Eziweigh 5	16 - 19
Quick Start Guide - Eziweigh 6	20 - 28
Quick Start Guide - ID3000 & XR3000	29 - 34
Electrical Installation Safety / Cleaning the Indicator	35
Trailer Set up	36 - 38
Optional Curved Race	39



General Overview

Handler Unit

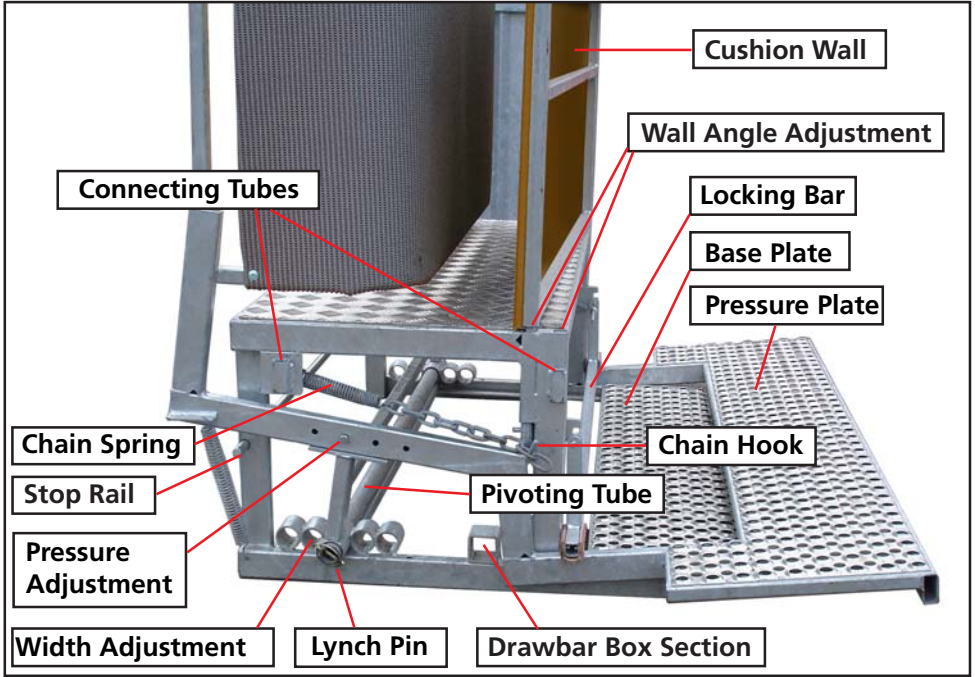

Fig 1

Approach Race

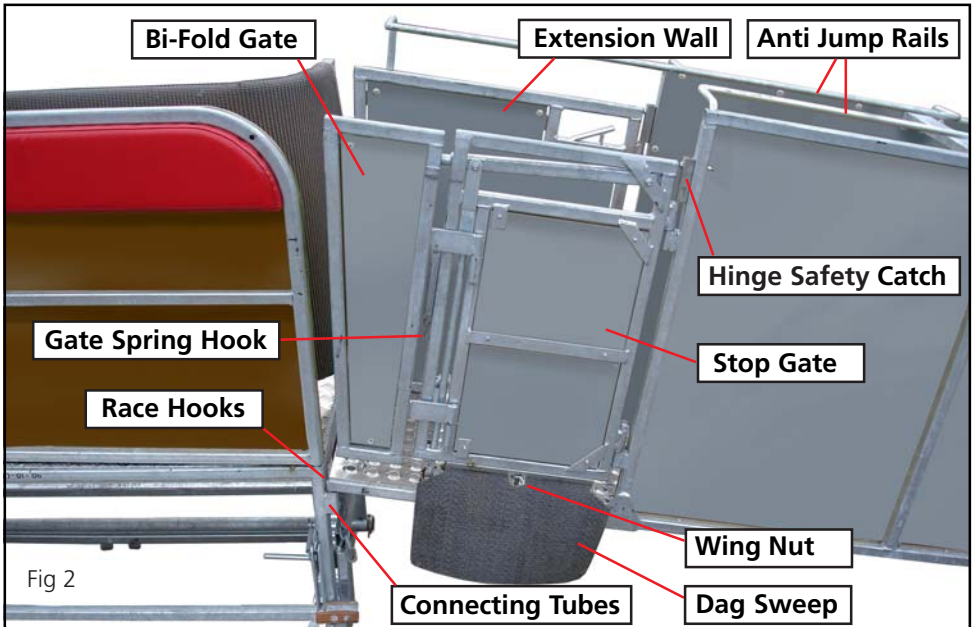

Fig 2

Setting up your Combi Clamp

SAFETY:- Always have an experienced stock person using the CombiClamp and wearing protective footwear.

When moving the Combi Clamp, always lock the Pressure plate down by lowering the Locking Bar.

Weights (unladen)

CombiClamp 150 kgs
Approach Race 90 kgs
3 Way Shedder 62 kgs
Drawbar 10 kgs
Axle 23 kgs
Long Curved Panel 27 kgs

To make the unit lighter, remove the gates from the approach race, and lift the cushion from the CombiClamp.

Where to set up:-

Firstly decide from which direction you want the sheep to enter the Handler from. A right handed dagger would set the Handler up so that the sheep are turning left from the drafting race or forcing pen, into the Handler.

A left handed dagger would set the Combi Clamp up so that sheep are turning right from the drafting race of forcing pen, to enter the Handler. The only time you would use the Handler in the opposite direction is for the drenching.

The first time that you use the Combi Clamp, we recommend that you place it going out the side drafting gate of your race, or if you have someone to chase up for you, it could be placed going straight ahead out of the drafting race.

How to set up:-

Remove the gates off the Handler's approach race, to make it easier to move. Remove the spring on the Bi-fold gate first. Push the spring towards the outside of the gate with

your left hand, then hold it with the right hand while you pull the hook out of the hole with your left hand. Remove the gates by swinging up the hinge safety catches first. Jam the Approach Race tightly into the gap left by the open, or removed, drafting gate. Slide the Handler around by holding the front edge of the pressure plate. Move it into position lining it up as close to the Approach Race as possible, facing the Handler, stand astride the Approach Race, where the gates are removed. Pick it up by the base and line the Race Hooks up with the Connecting Tubes, on the Handler, if the Handler is not quite lined up, lower one hook into the closed connecting tube, then pull the Handler towards you, to line up the other hook.

If using curved races, place these into the gap left by the open or removed drafting gate, position the approach race at the end of the curves, then attach to the Handler. Join the race to the curves, using the long pins provided. Check the angle of the Handler, ensuring that the sheep entering the Handler will have a clear view of the sheep that have already exited the Handler. This will draw the approaching sheep into the Handler. Reattach the Race gate. (Swing the safety catch out, to clear the top of the hinge, then swing back down again, one gate is swung). The extension wall, Fig 2, goes on the far side of the race, the Stop gate on the side closest to you. Attach the Bi-fold gate to the hinges on the outside of the Stop gate.

(if using the Combi-Clamp for dagging or Crutching hoggets or ewes, the Bi-fold gate can be left off. This enables you to dag through the gap without closing the gate for every sheep. You may need it on when dagging lambs as they may escape through the gap).

Leave the gate and Bi-fold gate in an open position. Hook the Bi-fold gate spring into a hole on the edge of the Stop gate by holding the spring with one hand and pulling it out and downward whilst positioning the hook with the other hand.

Position the Anti-jump rails into the holes on top of the approach race. The Anti-jump rails can be placed in either of the three holes

provided, Fig 3, or you can move the far Anti-jump rail forward one hole, so that it extends over the extension wall to prevent the sheep from jumping out over the side. When vaccinating, or any other procedures where you are working at the front of the Handler, both anti-jump rails can be moved into the forward position.

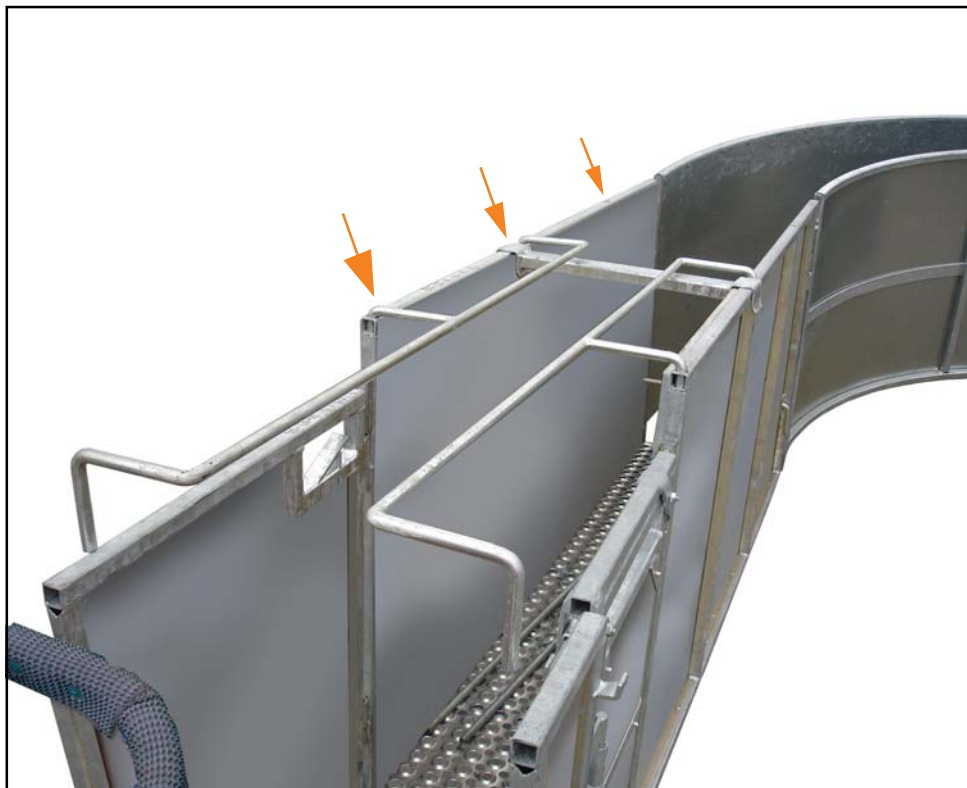

Fig 3



Replace the cushion wall at an angle, into the slots on the Handler, Fig 4. Make sure that you have the wall angled narrow at the shoulder end of the sheep, and wider at the back end. This will assist in preventing the sheep from slipping out.

To turn the Handler around, remove the gates on the Approach race, straddle the race and lift it off the Handler. Rotate the Handler around, ensuring the Locking rail is down before moving it.

Reattach the race and the gates, swapping them over from one side to the other. Change the angle of the Cushion wall. Alter the Anti-jump rails if you have one forward.

If storing your Combi-Clamp outdoors, please cover when not in use to prevent the Rubber wall from fading or hardening due to the effects of prolonged exposure to the sun.



Fig 4

Adjusting the Pressure for Sheep size and Operator Weight

Pressure adjustment: Before using your handler, you have to adjust the Pressure Adjustment to suit the body weight of the operator.

The Pressure Adjustment is labelled A, B, C, D.

A = for operators who are lighter than their ewes.

B = for operators who weigh the same as their ewes.

C = for operators who weigh slightly more than their ewes.

D = for operators who weigh a lot more than their ewes.

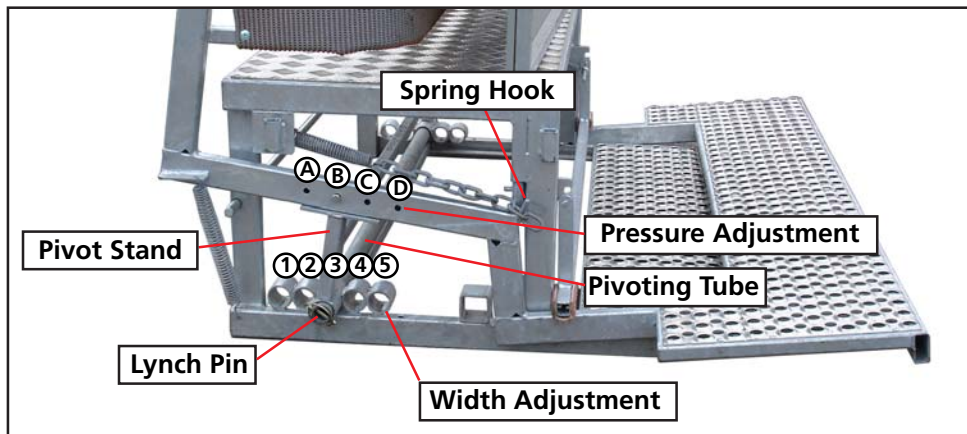

Fig 5

(Warning:- only move the pressure plate from the front edge, as stated below, to prevent the risk of hurting your fingers).

Firstly raise the Locking bar to allow the pressure plate to rise. Crouch in front of the pressure plate, and hold it up with your knee, then pull the chain towards you with both hands to disconnect the chain from the chain hook.

Repeat for the other end of the handler. Remove the pin from the pressure adjustment hole at both ends of the handler. Move to the front of the handler and grasp the pressure plate by the front edge, with both hands, and slide the pressure plate arm along to the chosen hole, lining both sides up evenly. Replace pins in the pressure adjustment.

(Replace chain if no Width Adjustment required).

Width Adjustment

After setting the Pressure Adjustment, then adjust the width of the handler to suit the size of the sheep that you are about to work on, the larger the sheep the wider the setting. The width adjustment is trial and error as there are a large range of ewe sizes and wool lengths. The following can be used as a guide.

A light operator would use

A or B 1,2,3 rams to lambs

A heavy operator would use

C or D 3,4,5 rams to lambs

If you need to change the width of the adjustment, remove the Lynch Pin from one end of the Pivoting Tube, (from under the approach race end, if connected to the handler).

Pull the Pivot tube out completely.

Once again grasp the pressure plate from the front edge and slide it either forward or back to line up to the desired tubes on the width adjustment. Slide Pivot Tube back into place, moving the pressure plate from the front edge only, if any minor adjustment is required to line up the tubes. Replace the Lynch Pin. Replace the chain by holding up the pressure plate with your knee, and pulling the chain towards yourself with both hands.

There should be enough tension on the chain spring to allow the Rubber Wall to fully open quickly, but to prevent the wall from bouncing, once in the open position.

Hints:- ideally you should be catching the average sized sheep with the **pressure plate no lower than 3-5 cm's above the Base Plate.**

This allows the pressure plate to travel lower to catch any skinny or smaller sized sheep, and still allow enough pressure to catch fatter and larger sheep.

If the **Pressure Plate is up high and bounces** with you on it holding a sheep in the clamp, you may have the **Width Adjustment too narrow.**

If the **Pressure Plate is touching the base plate**, and the sheep can escape, the **handler is set too wide.**

If the **sheep are able to push their way out** when you have them caught, and the Pressure Plate is not tight down touching the Base Plate, then you will need to **adjust both the width and the pressure** e.g. from B3 to A2.

The Pivot Stand needs to be further away from the Pressure Plate. This will give you more leverage.



Foot Positions for Operation

Caution:- Always use solid protective footwear when using your CombiClamp. Avoid placing toes under the edge of the pressure plate when closing.

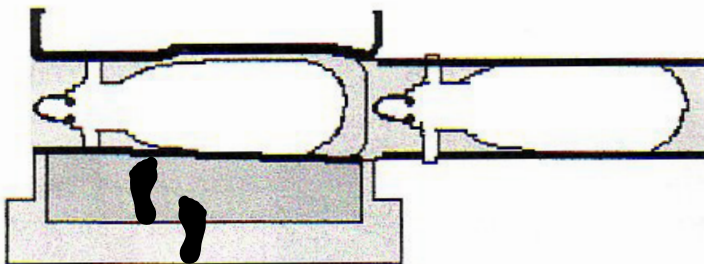

Weighing (with sheep entering from either direction)

Vaccinating (Right handed)

Alternate your leg position to prevent your legs from tiring.

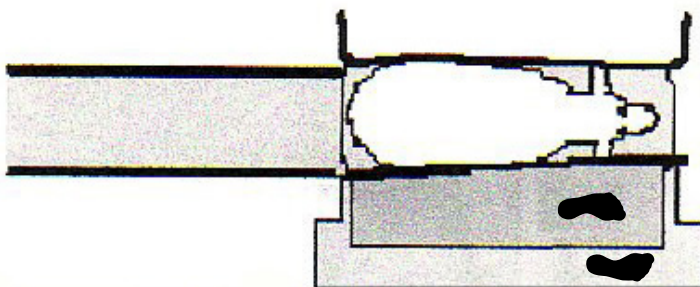

Drenching and Mousing (Right handed)

Mousing can also be done from the left hand side of the sheep, as per Vaccinating position.

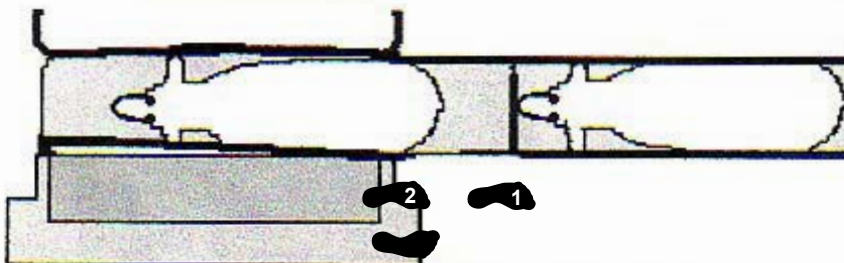

Dagging or Crutching (Right handed)

Bi-fold gate removed

Foot Positions for Operation (continued)

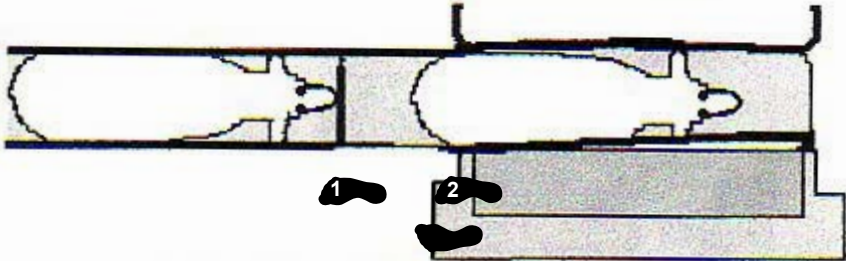

Dagging or Crutching (Left handed)
Bi-fold gate removed

(Use this method if you have to step forward to bring sheep up)

Stand with the inside foot (1) in front of handler and rest the toes of the outside foot (2) on the edge of the pressure plate. When the sheep enters, place your weight back on the outside foot, then step back onto the pressure plate with your inside foot. Lean your hip against the cushion and use your hand on the tail of the sheep to make it stand up or to adjust position. To adjust position of the sheep, take a little weight off the pressure plate, move sheep then apply pressure again, or walk along the pressure plate to the other end, hand under chin of sheep, raise pressure plate slightly whilst you adjust sheep, close down again, then walk back to dag position.

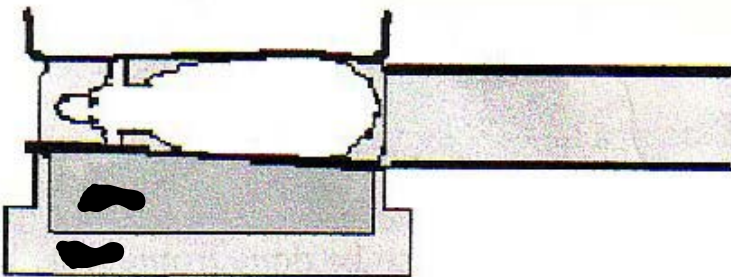

Capsuling

You may prefer to turn the Handler around



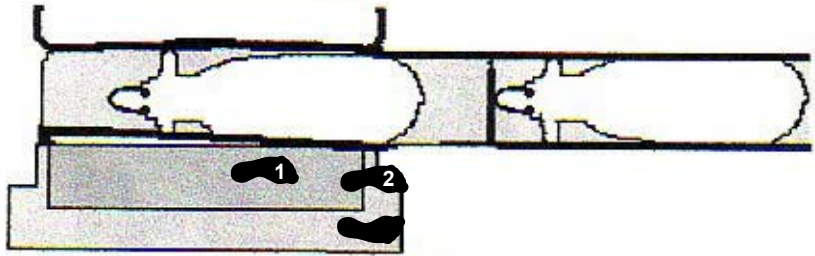

Right Hand Dag

Step forward with inside foot, once sheep is caught. Remove Bi-Fold gate when dagging ewes, then you can dag through the gap without closing the stop gate every time. Every time you open the stop gate, it will sweep out the dags.

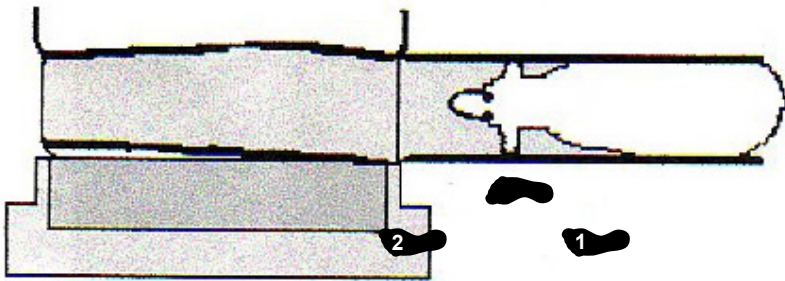

Chasing sheep up into Handler

Walk along behind the sheep with your hand on its tail. Time it so that you step onto the pressure plate with your outside foot.

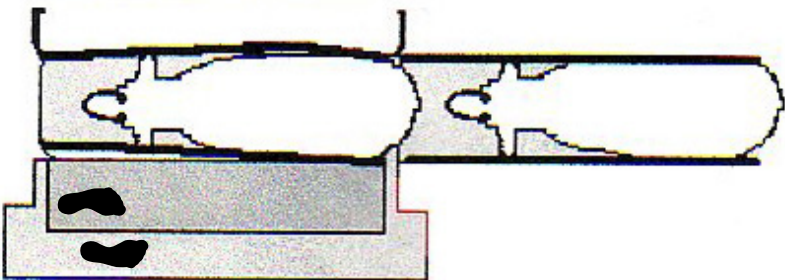

***Drenching**

Stand facing the oncoming sheep. Hide left arm behind yourself as sheep enters. Once caught, swing left arm under sheeps jaw. The sheep will raise its head allowing you to drench with right hand.

Reverse foot and Handler positions for Left hand operators.

Setting up the Weigh Frame (669g-800)

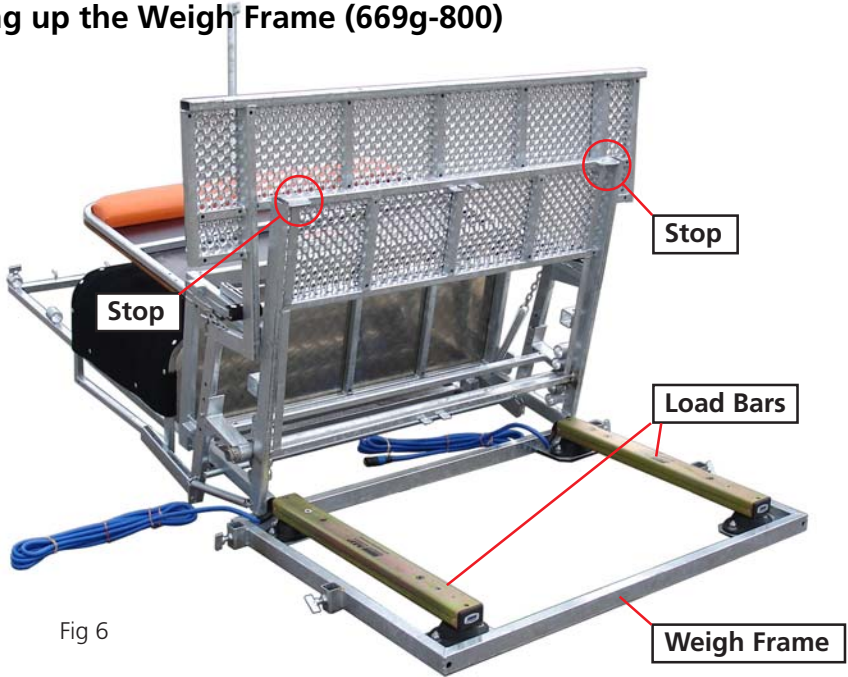

Fig 6

Set the Combi Clamp in position as required where handling operations are to take place. Tip the Clamp over until resting on its back, Fig 6.

Position the weigh kit as indicated with the cables to the rear.

The Combi Clamp can now be lifted back into the upright position to sit on top of the weigh kit.

Note: Take care to ensure cables are not snagged or trapped between clamp and weigh frame.

Push forward slightly allowing the Combi Clamp and stops to drop over the weigh frame, then pull back until the stops come to rest against the loadbars.

Fit the race support bracket at the ramp end, Fig 7, and secure with the pinch screws.

Lift the race into position allowing race hooks to slot into the top of the support bracket.

Slot the cover plate into the tube ends on the clamp, Fig 7.

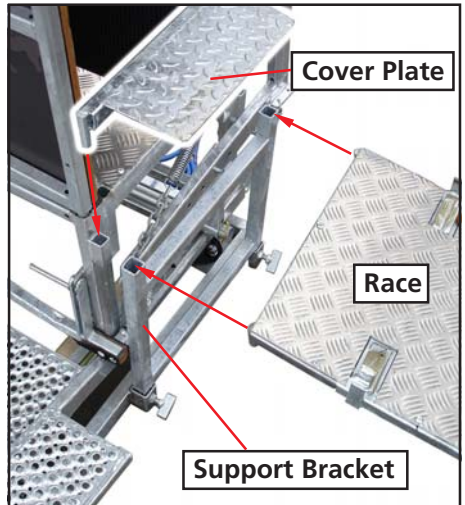

Fig 7

Note: Only fit the corresponding support bracket at the opposite end of the clamp if a 3 way shedder is to be fitted.

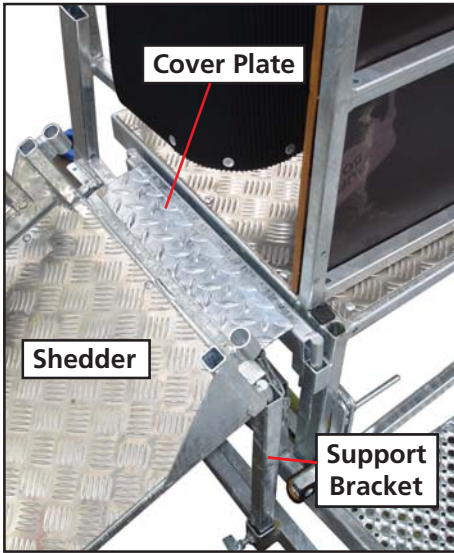

Fig 8

If fitting a 3 way shedder (669g-300) - fit the support bracket into the slots on the shedder side of the weigh frame Fig 8. Lift the shedder into position and slot into the top of the support bracket. Fit the cover plate supplied. The 3 way shedder should be fitted out ready for use as indicated in Fig 9.

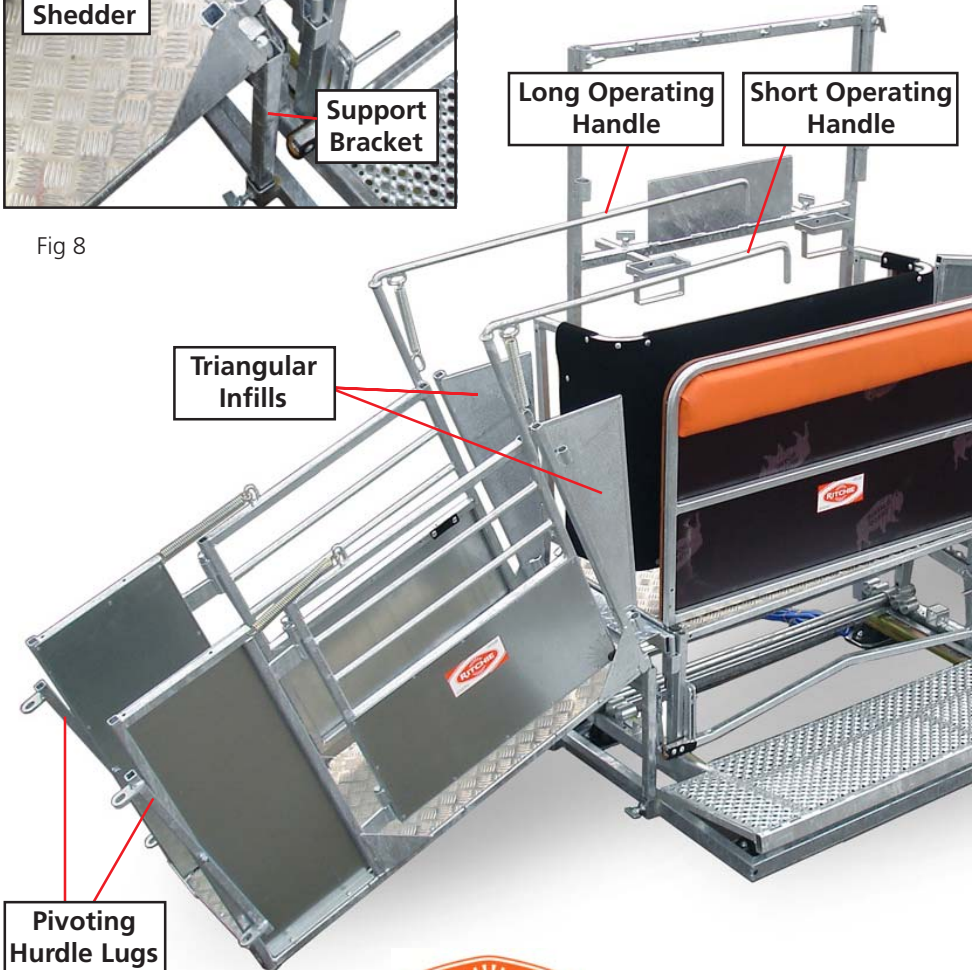

Fig 9



Auxiliary Frame (669g-600)

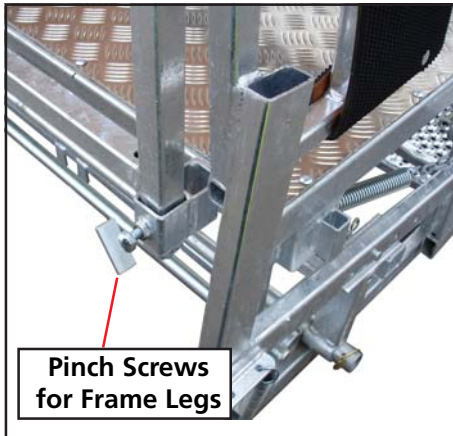

Fig 10

The Auxiliary Frame slots into the sockets at the rear of the clamp and is held in place by the pinch screws provided, Fig 10.

The Clipper frame can be fitted to either the left or right hand upright to suit the operator. Hooks are provided for dosing or vaccines, Fig 11. Holders for aerosols are provided which have adjustable extending arms.

The backplate has pre-drilled holes to suit the Tru-test weigh indicator mount bracket.

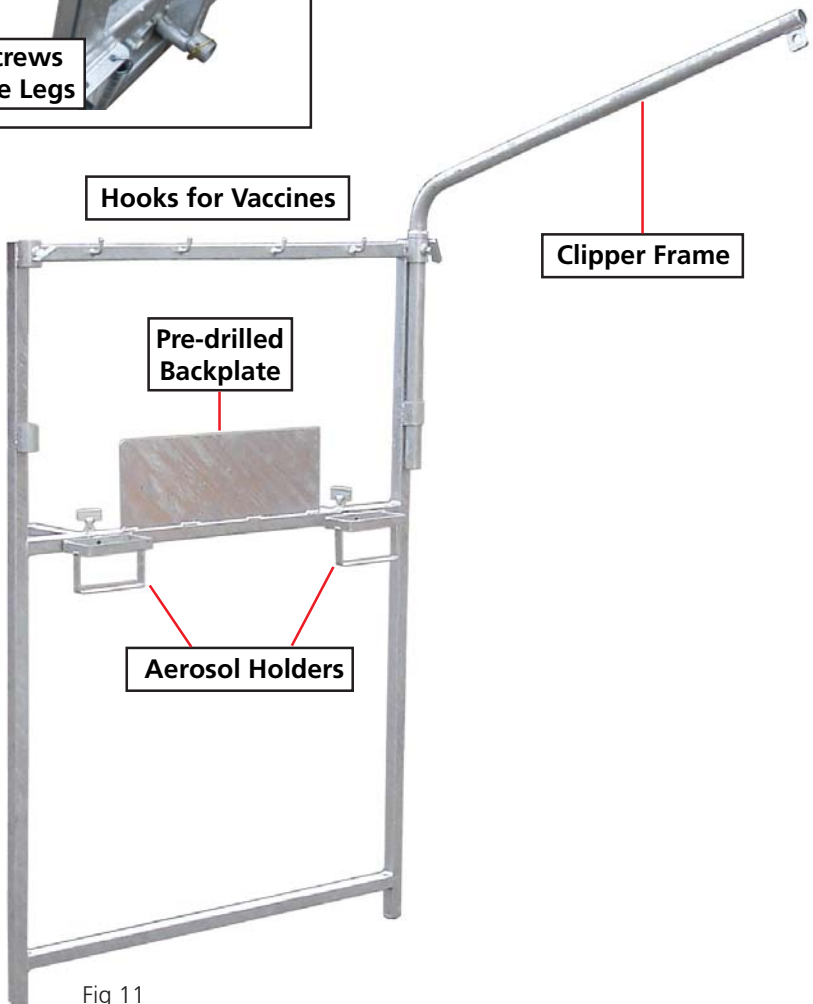

Fig 11

Tru-test Weigh Indicators

Eziweigh 5, 6, ID3000 and XR3000 Tru-test indicators are the 4 options available for weighing using the Ritchie 669g Combi Clamp.

Fit the indicator mount bracket to the backplate on the Auxiliary frame using the pre-drilled holes provided, Fig 12.

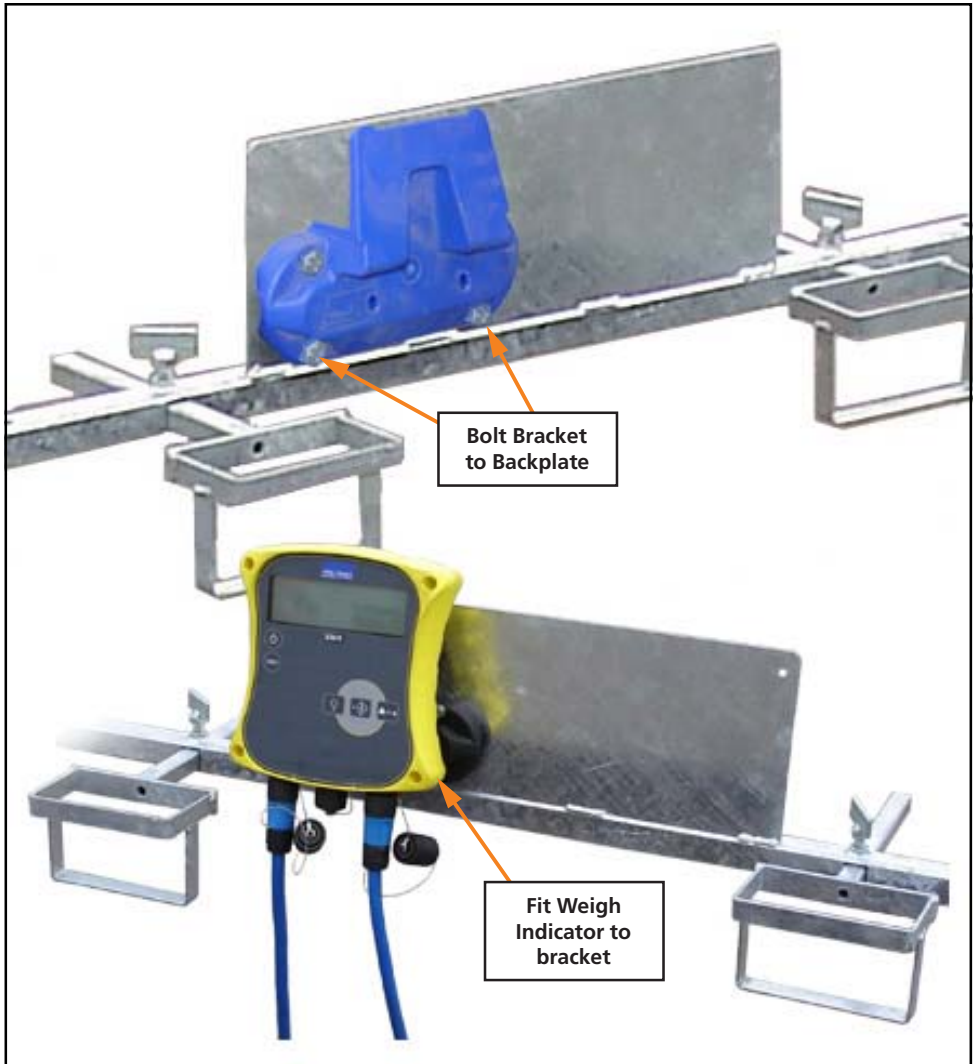

Fig 12

Quick Start Guide - Eziweigh 5

Before you start:-

Charging the internal battery

Note: Before using the indicator, ensure that the internal battery is fully charged.

- 3 When the Eziweigh 5 is plugged into the mains supply, the battery indicator scrolls, indicating that the battery is charging.
Note: When the indicator is unplugged from the power supply, the battery indicator displays the battery charge level.

- 2 Plug in the power adapter and switch on.

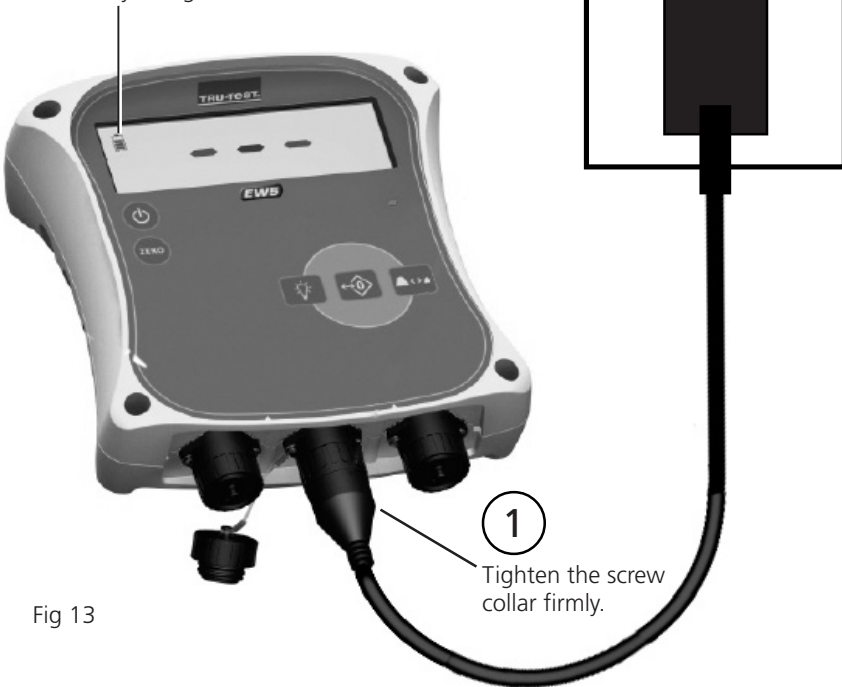

Fig 13

- 4 Leave the indicator on charge for 4 hours.

Note: The battery indicator may not be entirely accurate when the indicator is being used in very cold conditions (below 5 °C / 40 °F).



Installation

Note: Mount the indicator and secure the cables so they cannot be damaged by stock.

1. Remove the dust cap on the load cell connector and connect to either one of the two load cell sockets on the indicator.
2. If required, connect the indicator to the mains power using the power/communication cable and the power adaptor.

Tip: Connect the dust caps together to keep out dirt and moisture. Dust caps should remain in place at all times when the indicator is not in use.

Parts of the indicator

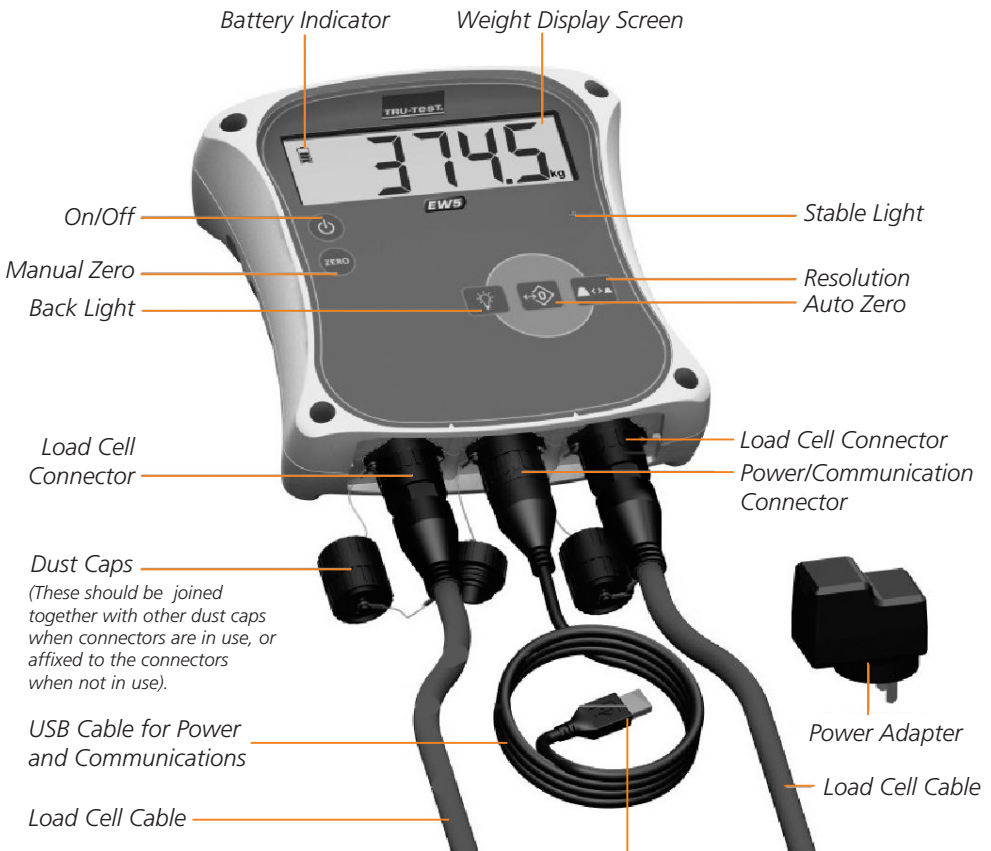



Fig 14

USB end
(for connection to the
Power Adapter)

Weighing animals

1. Press  to turn on the indicator.
2. Move the animal into the Combi Clamp.
3. Note the animal's ID and weight.
4. Wait for the stable light to illuminate.

When the animal is released from the Combi Clamp, the indicator automatically returns to zero.

Tip: Ensure that the underside of the equipment is kept clear of dirt and stones.

Zeroing the scale manually

By default, the scale automatically zeroes itself when a load is removed from the weighing platform or when the indicator first powers up. Occasionally, you may need to use the manual zero to force the scale to return to zero, for example if there is a build-up of dirt or stones in the Clamp.

To zero the scale manually:

Press .

The scale displays zero.

Modifying the indicator settings

There are several settings which may be customised to suit the weighing application or the environmental conditions.

To view an indicator setting:-

press Auto Zero = 

Resolution = 

or Backlight = 

The current setting is displayed on the weighing display screen.

To modify an indicator setting, press the required button repeatedly to scroll through the options. Once the desired option is displayed, wait momentarily for the indicator to return to the weighing display.



Auto zero

By default, the scale automatically zeroes when a load is removed from the Clamp or when the indicator first powers up.

Auto Zero should be **ON** when used with the 669g Combi Clamp.

If for any reason you want to disable Auto Zero - consult the Tru-test manual or go to www.tru-test.com.

Modifying the resolution

You can select from 0.1kg, 0.2kg, 0.5kg or 1kg weighing resolutions.

By setting the resolution to 1 kg, the indicator will weigh to the nearest kilogram and arrive at a weight more quickly. If you are weighing light loads, for example small animals, you may require more accurate measurements. By setting the resolution to 0.1 kg, the indicator will weigh to the nearest tenth of a kilogram, although it may take longer for the scale to stabilise.

To modify the resolution:

Press  repeatedly to set the resolution.

Adjusting the backlight

You can adjust the backlight to suit the lighting conditions. Use of the backlight will affect battery consumption – the run-time will double if the backlight is set to Low instead of High.

To modify the backlight setting:

Press  repeatedly to set the backlight to High, Off or Low.

Specifications

Total Capacity	2000kg
Resolution	Set to 0.5kg (fine mode 0.1kg) or 1lb (fine mode 0.2lb)
Accuracy	+/- 1% or 2 resolutions (whichever is greater)
Power Supply	5 V DC (power adapter)
Operating temperature	-10 to + 40° C (+ 14 to +104° F)
Storage temperature	-20 to + 35° C (-4 to +95° F)
Internal battery run time	Up to 20 hours
Environmental	IP67 (immersion in up to 1 m (3') of water)



Quick Start Guide - Eziweigh 6

This quick start guide provides basic instructions for installing and using your EziWeigh6 indicator. For more detailed instructions, see the CD included with the indicator, or visit - www.tru-test.com.

Before you start:-

Charging the internal battery

Note: Before using the indicator, ensure that the internal battery is fully charged.

- 3 When the Eziweigh 6 is plugged into the mains supply, the battery indicator scrolls, indicating that the battery is charging.
Note: When the indicator is unplugged from the power supply, the battery indicator displays the battery charge level.

- 2 Plug in the power adapter and switch on.



- 1 Tighten the screw collar firmly.

Fig 15

- 4 Leave the indicator on charge for 4 hours.

Note: The battery indicator may not be entirely accurate when the indicator is being used in very cold conditions (below 5 °C / 40 °F).

Installation

Note: Mount the indicator and secure the cables so they cannot be damaged by stock.

1. Remove the dust cap on the load cell connector and connect to either one of the two load cell sockets on the indicator.
2. If required, connect the indicator to the mains power using the power/communication cable and the power adaptor.

Tip: Connect the dust caps together to keep out dirt and moisture. Dust caps should remain in place at all times when the indicator is not in use.

Parts of the indicator

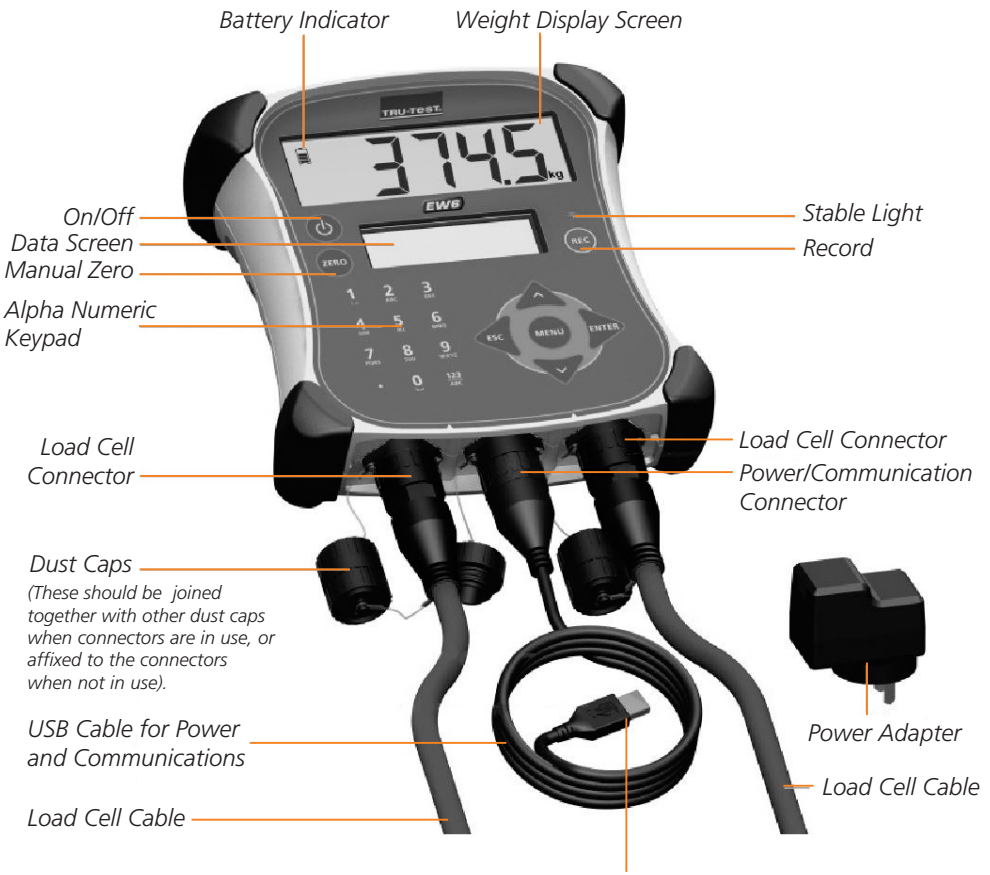



Fig 16

USB end
(for connection to a PC
or to the Power Adapter)

Weighing animals

1. Press  to turn on the indicator.
2. Move the animal into the Combi Clamp.
3. Enter the animals VID using the alpha numeric keypad, or scan the animals EID tag using an EID reader.
4. Wait for the stable light to illuminate.
5. Press 

When the animal is released from the Clamp, the indicator automatically returns to zero.

Notes:

- Entering the animals ID is optional.
- The animals VID or EID may be entered before the animal enters the Combi Clamp.
- When inducting new animals, both the VID and EID can be entered.

Tips:

- Ensure that the animal is fully held in position in the Clamp before pressing 
- Ensure that the underside of the Clamp is kept clear of dirt and stones.

Using the indicator interface

Press  to view the menu items. The top level of menus includes:

Statistics	View Statistics for the current session, or for previously recorded sessions
Clear last record	Delete the last record in the current session.
Sessions	Start a new session, view statistics for the current session or for previously recorded sessions, delete a session or delete all sessions
Setups	Change indicator settings and enable extra features

Press  to go deeper into a sub-menu or to select an option.

Press  or  to scroll through a list of options.

Press  to escape out of a sub-menu back to the next tier up.

Use the alpha numeric keypad to enter text or numbers.

Press  to toggle between alphabet characters and numbers.

Press  to type a decimal point or full-stop.

With alphabet characters set, press  once to type a colon (:.) or twice to type a hyphen (-).

With alphabet characters set, press  to type a space.

Zeroing the scale manually

By default, the scale automatically zeroes itself when a load is removed from the weighing platform or when the indicator first powers up. Occasionally, you may need to use the manual zero to force the scale to return to zero, for example if there is a build-up of dirt or stones in the Clamp.





To zero the scale manually:

Press 

The scale displays zero.







Sessions

To create a new session:



1. Press 
2. Press  ,  to display **Sessions**.
3. Press  to display **Start New**.
4. Press  .

A message **Started** is displayed.

To view statistics for a particular session:

- 1 Press 
- 2 Press  ,  to display **Sessions**.
- 3 Press 
- 4 Press  to display **Statistics**.
- 5 Press 

A session date is displayed, followed by the count (number of records in the session).

Press  to view the statistics for that session or, press  to view statistics for a different session.





Viewing statistics for a session

Statistics can be viewed for a particular session:







Count	Number of records in the session
Average	Average weigh recorded in the session <i>Note: Records with no weighs are ignored in the average</i>
Total	Total of all weighs recorded in the session
Min	Minimum of all weight recorded in the session
Max	Maximum of all weight recorded in the session
Low Count	Count of animals in Low range (only if Drafting is enabled)
Medium Count	Count of animals in Medium range (only if Drafting is enabled)
High count	Count of animals in High range (only if Drafting is enabled)

Note: Draft statistics can only be viewed for the current file.

To view statistics for the current session:

- 1 Press  to display **Statistics**.
- 2 Press 
- 3 Press  to scroll through the list of statistics.



To view statistics for another session:

1. Press  to display **Statistics**.
 2. Press 
 3. Press  repeatedly until **Other Sessions** is displayed.
 4. Press 
- A session date is displayed.
5. Press  to view the statistics for that session or, press  to view statistics for a different session.









Deleting data

To delete the last record in the session:







1. Press 
2. Press  to display **Clear Last Record**.
3. Press 

To delete the oldest session on the indicator:

1. Press 
2. Press ,  to display **Sessions**.
3. Press 
4. Press ,  to display **Clear Oldest Session**.
5. Press 







Note: ID information remains in the indicator.

To delete all the sessions on the indicator:

1. Press 
2. Press ,  to display **Sessions**.
3. Press 
4. Press  repeatedly until **Clear ALL Sessions** is displayed.
5. Press 

Note: ID information remains in the indicator.

To delete all data on the indicator:

1. Press 
2. Press ,  to display **Sessions**.
3. Press 
4. Press  repeatedly until **Clear ALL Sessions & VID-EID Links** is displayed.
5. Press 

Note: All data, including ID information is deleted.

Setups

The indicator can be customised to suit the weighing application or environmental conditions. The settings are accessed through the Setups menu.

Drafting





Drafting allows you to sort animals into two or three groups according to their weights. During weighing, the indicator displays the weight range the animal belongs in: <LOW>, MEDIUM> or <HIGH>.

There are two draft limit settings: a low limit and a high limit. The draft limits are the 'splitting points' for the groups.









For two-way drafting, enter a weight for one of the draft limits (leaving the other set to zero). For example, to draft animals below 75 kg into one pen and heavier animals into another, set the low limit to 75 kg and set the high limit to 0 kg.

For three-way drafting, enter a weight for both the low limit and high limit. For example, to draft animals into three pens 0-50 kg, 50-100 kg and 100+, set the low limit to 50 kg and the high limit to 100 kg.

To enable drafting:

1. Press 
2. Press  repeatedly to display **Setups**.
3. Press  to display **Draft**.
4. Press 
5. Press  to enable drafting.





To enter a range for the low and high limits:

1. Press 
2. Press  repeatedly to display **Setups**.
3. Press  to display **Draft**.
4. Press 
5. Press  to display **Low Limit**.
6. Type a value for the low limit range using the alpha-numeric keypad.
7. Press 
8. Press  to display **High Limit**.
9. Type a value for the high limit range using the alpha-numeric keypad.
10. Press 

Backlight

The backlight is set to Off by default, however you can set it to Low or High to suit poor lighting conditions. Use of the backlight will affect battery consumption – the run-time will double if the backlight is set to Low instead of High.

To modify the backlight setting:





1. Press 
2. Press  repeatedly to display **Setups**.
3. Press 
4. Press  repeatedly to display **Backlight**.
5. Press  once to change the Backlight to Low or twice to change it to High.

Resolution

You can select from 0.1kg, 0.2kg, 0.5kg or 1kg weighing resolutions.

By setting the resolution to 1 kg, the indicator will weigh to the nearest kilogram and arrive at a weight more quickly. If you are weighing light loads, for example small animals, you may require more accurate measurements. By setting the resolution to 0.1 kg, the indicator will weigh to the nearest tenth of a kilogram, although it may take longer for the scale to stabilise.

To set the minimum weighing resolution:

1. Press 
2. Press  repeatedly to display **Setups**.
3. Press 
4. Press  repeatedly to display **Resolution**.
5. Press  repeatedly as required to modify the resolution setting.

Auto zero



By default, the scale automatically zeroes when a load is removed from the weigh platform or when the indicator first powers up.

Auto Zero should be **ON** when used with the 669g Combi Clamp.

If for any reason you want to disable Auto Zero - consult the Tru-test manual or go to www.tru-test.com.









Damp System

Damping is the length of time it takes in order for the indicator to settle on a weight. The damping system selected will depend on what you are weighing (sheep, produce, feed etc).

Superdamp III Cattle	Ideal weighing system for weighing cattle
Superdamp III Sheep	Ideal weighing system for weighing sheep
Fixed weighing time	You can specify the weighing time
Averaging	The average weight for a specific number of seconds is continually displayed. Used for non moving weights such as produce and feed. You can specify the weighing time.

To modify the damp system setting and set the weigh time:

1. Press 
2. Press  repeatedly to display **Setups**.
3. Press 
4. Press  repeatedly to display **Damp System**.
5. Press  repeatedly as required to modify the damp system setting.
6. Press  to display **Weigh Time**.
7. Press  repeatedly as required to modify the weighing time.

Note: The Weigh Time option is only available if Fixed Weighing Time or Averaging has been selected as the Damp System setting.

Specifications

Total Capacity	2000kg
Resolution	Set to 0.5kg (fine mode 0.1kg) or 1lb (fine mode 0.2lb)
Accuracy	+/- 1% or 2 resolutions (whichever is greater)
Power Supply	5 V DC (power adapter)
Operating temperature	-10 to + 40° C (+ 14 to +104° F)
Storage temperature	-20 to + 35° C (-4 to +95° F)
Internal battery run time	Up to 20 hours
Environmental	IP67 (immersion in up to 1 m (3') of water)



Quick Start Guide - ID3000 & XR3000

Important : Follow the instructions below before using the indicator.

Note: Some of the information and features noted in the following pages may be applicable to the XR3000 model only.

Connections

The indicator should be mounted on the backplate using the holes provided. Position the indicator so that the screen is out of the sun if possible.

Connect the load cell cable to the indicator. Connect dust caps together to keep out dirt and moisture.

Connect the power cable (if using an external 12V supply)



Fig 17

Communications connectors for connecting to computer, printer, EID reader etc.

Power connector for connecting 12V vehicle battery (red clip to positive terminal) or Tru-test power adaptor.

To connect power adaptor, pull battery clips off indicator lead and plug lead into power adaptor lead (red to red).

Load cell connectors (Dust caps screw together to keep out dirt and moisture when cables are connected to the indicator. screw back on indicator/cables when cables removed).

Overview

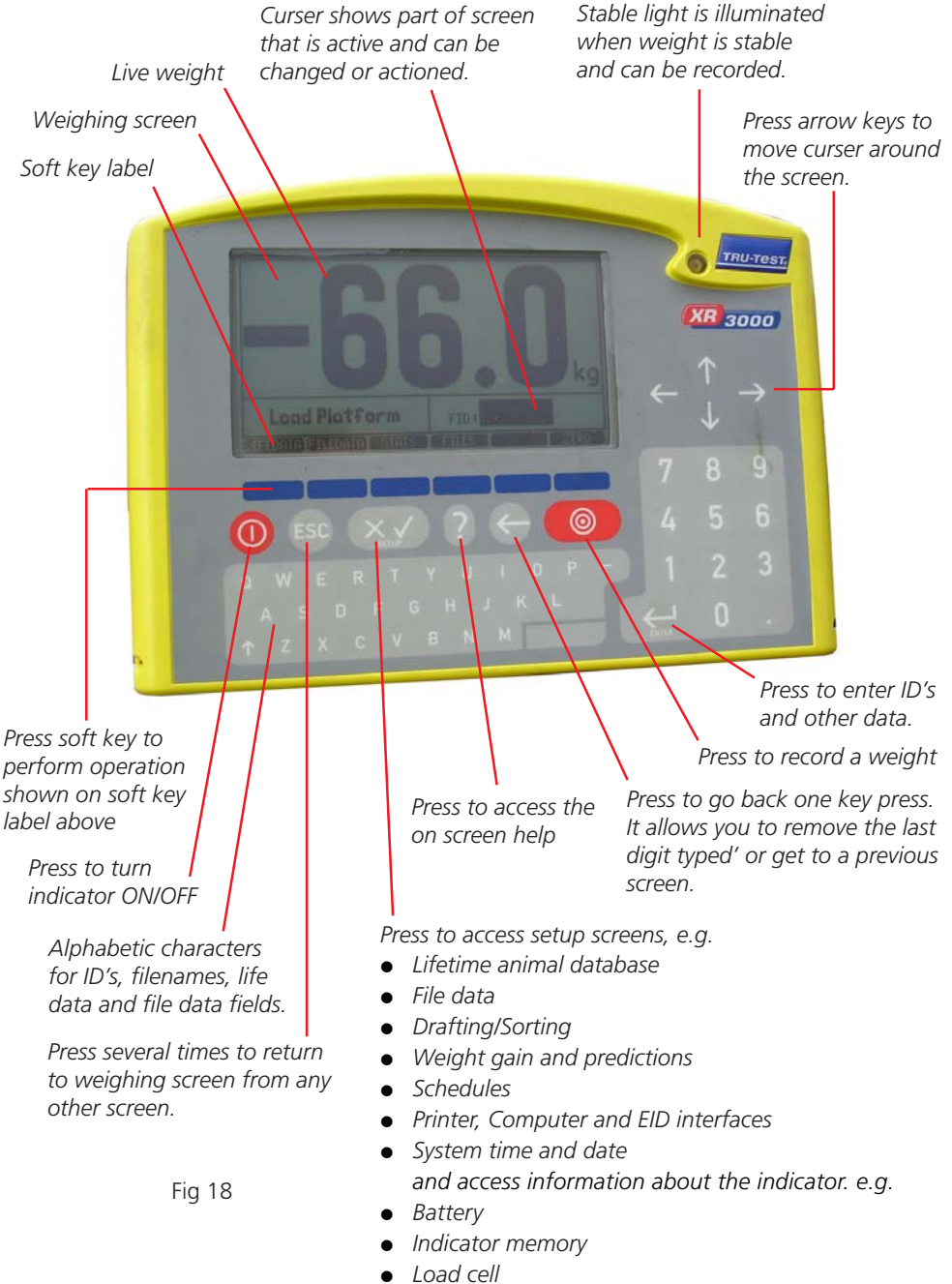

Fig 18

Weighing Screen Soft Keys

- FILES** Displays a list of files. each file typically represents one weighing session. There are 200 files.
- LIFEDATA** Displays information likely to remain the same during the lifetime of animals e.g. ID, breed. More than one ID can be entered for an animal. ID's are cross referenced, so that any ID can be entered in order to display animal information. Life data can be viewed and edited. There is one lifetime animal database.
- FILEDATA** Displays information recorded in the weighing session e.g. weights, measured data, drafting ranges, together with relevant life data. File data is linked to life data via the ID. File data can be viewed and edited.
- STATS** Displays calculations for animals in the file e.g. average, total, minimum and maximum weights.
- ZERO** Zeroes the scale manually. Used if dirt builds up on the weigh platform floor. Zeroing is usually automatic.

Getting Started

To start a file for a new weighing session:

1. Press **FILES** to go to the List of Files screen.
2. Select an empty file.
3. Enter a name for the file using the keypad. Press ←
4. Press (ESC)

The file Start date is entered automatically when the first weight is recorded.

To record an animal ID and weight:

1. Press **ZERO** to zero the scales, if required.
2. Move the animal into the Combi Clamp.
3. Enter an ID using the keypad. Press ←
If the animal has not been weighed before a dialogue box appears.
4. Select 'Create a new lifedata record'. Press ←
5. Enter other data, if required.
6. Press (ENTER) when ready to record the displayed weight.
7. Repeat for each new animal.



To view all recorded data from the weighing session:

▶ Press **FILEDATA** to view weights and other data recorded in the weighing session.

To view statistics:

▶ Press **STATS** to view a summary of numerical data, for example, average weight, maximum weight and the number of file data fields recorded in the file.

To enable an option in a set up screen:

1. Place the cursor on the option you want to enable or disable.
2. Press **←**
3. Select an option using the arrow keys.
4. Press **←**

TIP To change **×** to **✓** quickly, press **1**
To change **✓** to **×** quickly, press **0**

Weighing Screen Setup		FILE 1
Tick the items you want on the main weighing screen		
LHS (FOR VIEWING)	RHS (FOR DATA ENTRY)	
<input checked="" type="checkbox"/> Prompt message <input type="checkbox"/> Draft range <input type="checkbox"/> Carcass Weight <input type="checkbox"/> Value <input type="checkbox"/> Weight gain <input type="checkbox"/> Prediction <input type="checkbox"/> Days ----- <input type="checkbox"/> FID <input checked="" type="checkbox"/> EID	<input checked="" type="checkbox"/> FID <input type="checkbox"/> EID <input type="checkbox"/> LID <input type="checkbox"/> Mob <input type="checkbox"/> Class <input type="checkbox"/> Breed <input type="checkbox"/> DOB <input type="checkbox"/> Spare ----- <input type="checkbox"/> CODE 1	
LIFEDATA	FILEDATA	DRAFT
w. GAIN	SYSTEM	▶▶

Find out about any field, screen or feature, using the on screen help.

To view on screen help:

1. Place the cursor on the field you want to find information about.
2. Press **(?)**
A help screen is displayed about the field you are on.
3. If required, move the cursor to a link and press **(?)**

Help Screen

Select link, then press **?** to see a step by step guide

Select link, then press **?** to see more information about the screen you are in

Select link, then press **?** to see a list of help topics. Enter the first few letters of the word you want to find

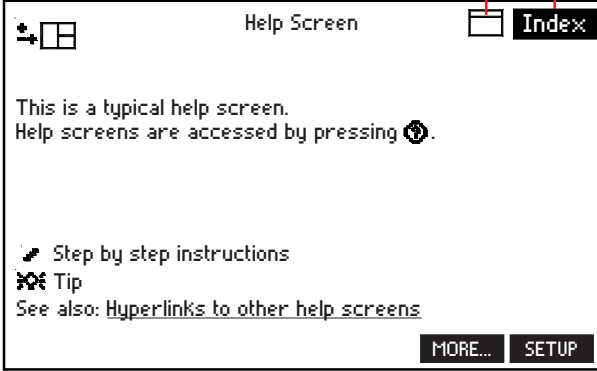

-or-
Use arrow keys to scroll up and down the list. Select a word and press **↵**

Select link, then press **?** to see a handy tip about this feature

Battery Information

- The internal battery charger operates from the recommended Tru-test power adaptor or a 12 volt vehicle battery.
- The indicator switches off automatically after 15 minutes of inactivity. Auto power Off feature can be disabled by pressing **XV** then **SYSTEM**. Press **0** to change **V** to **X**.
- The indicator should be charged for 12 hours before it is used for the first time.
- To view Battery information including charge (%) and Time to Run (hours and minutes), press **XV**, **▶▶** then **BATTERY**.
- A flat battery takes 8 hours to charge at temperatures of 10°C to 35°C. For temperatures outside this range, charging times may be increased to 12 hours. In very extreme temperatures, the indicator may not charge.
- The indicator may be left on charge at all times and the scale can be used while charging.



Maintenance and Storage

- Make sure the underside of the Combi Clamp is free from dung, dirt and stones.
- Store the indicator in a clean, dry place, out of direct sunlight and cover the load cell when not in use.
- Charge the indicator overnight before and after long term storage, and every three months during storage.

Latest Information and Software Downloads

For up-to-date information about Tru-test products and downloads of latest software versions for your indicator, visit the Tru-test website at www.tru-test.com

You can download Link3000 to transfer data from your indicator to your computer.

For repair and service information, contact David Ritchie (implements) Ltd. at the address on the back cover of this manual.

Specifications

Dimensions	270 x 190 x 71
Weight - ID3000 - XR3000	Battery option = 1.6kg (3½ lb), non battery = 1.4kg (3 lb) 1.6kg (3½ lb)
Accuracy	+/- 1% or 2 resolutions (whichever is greater) minimum base resolution 0.5kg (0.1lb) normal, 0.1kg (0.2lb) fine.
Battery	Charging time = 8 hours in normal conditions; Run time = 15 hours continuous use minimum with two load cells (8 hours with back light on). Auto turn off is 15 minutes.
Power requirements	AC adaptor (regulated) or battery, using crocodile clip 11 to 16 V d.c., 400 mA.
Display	High contrast, wide temperature LCD module, 240 x 128 dots.
IP67 waterproof rating	The indicator is 100% water and dust proof. It can be submerged in water to a depth of 1 m for 30 minutes.
Environmental	Operating temperature: - -10 to + 40° C (+ 14 to +104° F) Storage temperature: - -20 to + 35° C (-4 to +95° F)
Loadbar Capacity	Power for up to 8 (350 ●) load bars or load cells.
Communication	2 x D9, one interface RS485 or RS232, the other RS232 only. Allows for connection to a printer and/or computer.



Warnings



Safe installation - Safety

For your protection all mains (110V or 230V) equipment used out of doors or in wet or damp conditions should be supplied from a correctly fused source and protected by an approved RCD to BS7071 or BS7288 or IEC1008-2-2 BS EN 61008: 1995.

The mains lead must be connected to a supply outlet with a **protective earth contact**. The electrical supply at the socket outlet must provide over current protection of an appropriate rating.

IF IN DOUBT SEEK THE ADVICE OF A QUALIFIED ELECTRICIAN.

Pluggable equipment must be installed near an easily accessible socket outlet. Permanently connected equipment must have a readily accessible disconnect device incorporated in the fixed wiring.



To avoid the possibility of electric shock or damage to the equipment, always switch off and isolate from the power supply before carrying out any routine maintenance.

Cleaning the Indicator



Caution

Harsh abrasives, solvents, scouring cleaners and alkaline cleaning solutions, such as washing soda, should not be used especially on the display window. Under no circumstances should you attempt to wipe the inside of the weigh head.

The outside of the product is waterproofed to IP67 and should be wiped down with a clean cloth, moistened with water containing a small amount of washing up liquid or proprietary detergent.

Note: The Instructions given in this manual are intended to allow the operator to install and start using the indicator. More detailed instructions are available on the CD which accompanies the indicator, or you can go to www.tru-test.com.

Software Upgrade

The latest version of software can be downloaded from www.tru-test.com. Instructions for upgrading are provided with the download.



Trailer Set Up (669g-700)

To set the handler up as a trailer unit, the handler firstly has to be set at a width adjustment and pressure setting that leaves the draw bar box section exposed. (refer to handler picture, Fig 1).

1. Separate the race from the Handler.
2. Lock pressure plate in closed position. Raise handler up to stand on one end. (The end that the sheep will enter from when you next use the Combi-Clamp)
3. Remove "D" pin from draw bar, then lean drawbar against underside of handler, with coupler at the top, Fig 19, being careful that it does not fall.

4. Position axle between square shaped lugs located on each side of the underside of the handler, lining up the box section on the draw bar and handler. (Make sure that the letter 'P' that is welded on the axle, is placed on the pressure plate side of the handler. This is because of the off-set draw bar).

Rest one knee against the axle to prevent axle from falling out, then raise the towbar above the handler, with the coupler upmost, and lower drawbar down through box section from above the handler, Fig 20, through the axle box section, then handler again, making sure that you have the drawbar facing the right way up. Once drawbar is in position, hold onto the coupling end of drawbar and lower the handler onto it's wheels, being careful that the drawbar does not slide out of the box section.

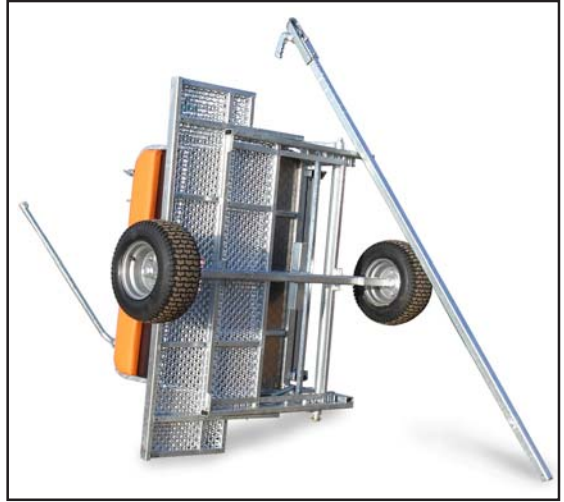

Fig 19



Fig 20



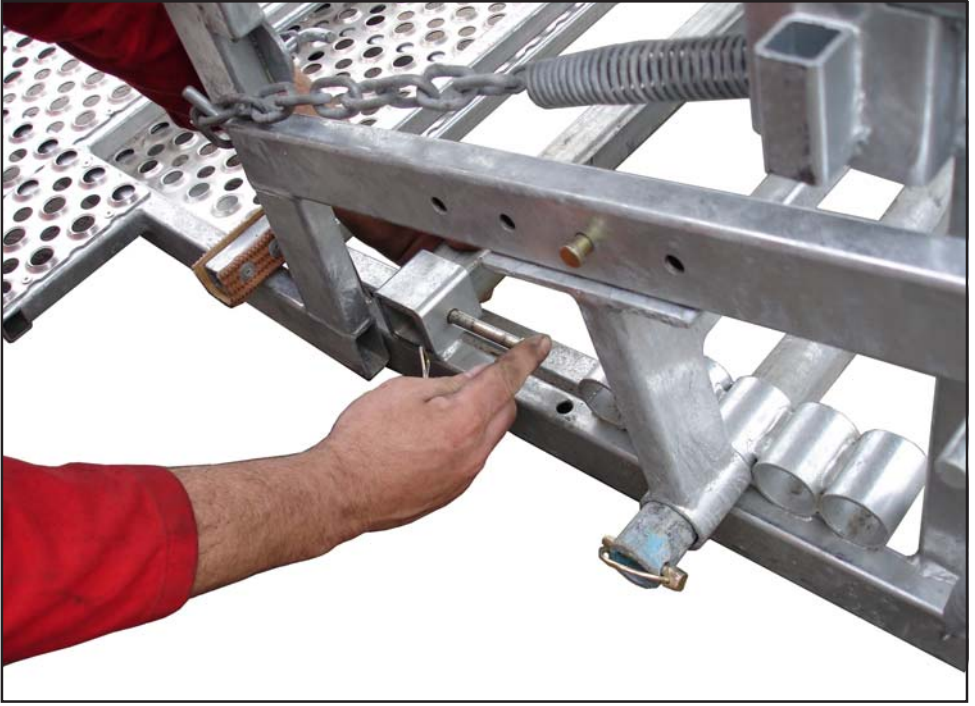

Fig 21

Secure drawbar by placing 'D' pin in through the hole on the far end of the drawbar, and handler box section, Fig 21.

5. Wheel trailer unit to halfway alongside the approach race, with the gate end of the race facing towards you. Leave the drawbar raised above the ground and the far end of the handler resting on the ground. Remove all the gates from the approach race to lessen the weight, lift race by the hooks at front of race, and swing the race over the pressure plate and against the cushion wall, slide the race completely against the wall, Fig 22.



Fig 22



6. Replace gates with the extension wall against the handler side, and Bi-Fold gate, in a closed position, on the outside of race, lift the anti-jump rails slightly at the gate end of the race, and fit wall brace over the top of walls.

Tie Downs - Using the tie-down, hook the long strap onto ring on pressure plate side of axle. Pass the strap around the back of race above the two hinges, Fig 23.

Hook ratchet end onto top side of axle on the other side of handler. Fit tie down together then adjust to take up slack only. (this is to be tightened later).

Repeat for the front tie down. Tighten up both ratchets firmly, but not over tight, as this can bend the race walls. Roll up excess straps and secure.

If you own a Standard Unit, you are ready to go.

If you also own a 3 way draft -

After you have fitted the approach race onto the pressure plate, don't fit the extension wall and bi-fold gate. (These will go inside the approach race). Fit the 3 way draft onto the approach race at the front of the trailer and over the axle, Fig 24.

Place all remaining loose items on the floor of the approach race.

Important:- the Tie-Downs are 500 daN rated and very strong, so be careful that you don't over tighten them resulting in bent race walls, etc.

Important

Check trailer wheels regularly.

Torque setting for wheel nuts - 85Nm.

Tyre pressure - 25 psi.



Fig 23



Fig 24

Optional Curved Race (669g-500)



Fig 25

An optional Curved Race can be added if required by fitting joining rods through connecting tubes, Fig 25.





the perfect partner

David Ritchie (Implements) Ltd,
Carseview Road, Forfar, Scotland, DD8 3BT
Tel: 01307 462271 fax: 01307 464081
e-mail: agrisales@ritchie-uk.com
www.ritchie-uk.com